

TANITA



DIGITAL BABY SCALE

MODEL 1584

OWNER'S MANUAL

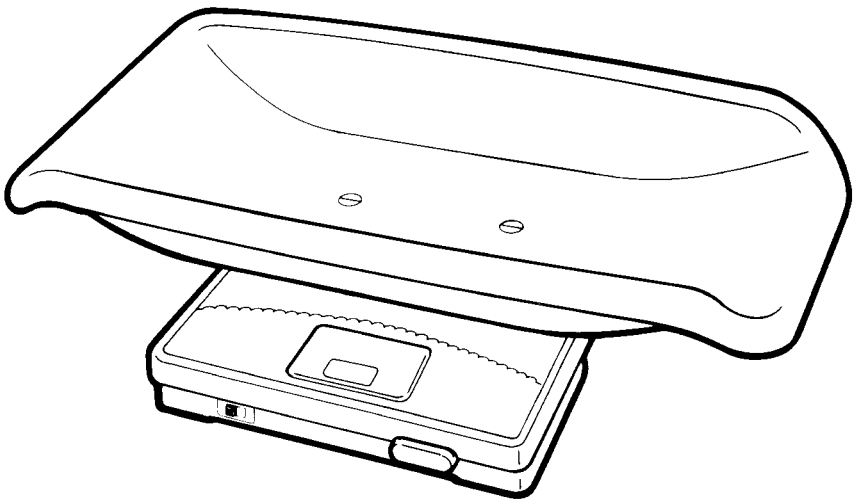

THIS FINE INSTRUMENT IS
PRECISION — CRAFTED BY

TANITA CORPORATION

TOKYO, JAPAN

Specification

MAX—20kg	0—10kg/20g	10—20kg/50g
MAX—44lb	0—20lb/1oz	20—44lb/2oz
Power supply	4pcs of R03 (IEC) or AAA	

Name of Parts

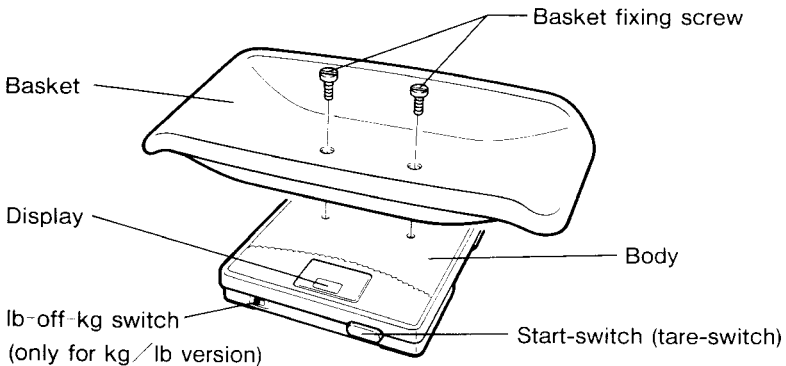

Setting up for operation

Turn the scale over and remove the battery cover by releasing the latch. (see fig. 1)
Install 4 PCS OF NEW "R03" OR "AAA" TYPE ALKALINE BATTERY with correct polarity as indicated (see fig. 2).

- Note:
- If "Lo" message appears in display when attempting to weigh, replace the batteries. "Lo" will not appear if battery voltage is too low.
 - When the batteries are installed, the power of the scale is on even without pushing the start switch in some occasion. In this case, leave the scale and wait about one minute to let the scale turn off automatically. If the display keeps on after one minute, please try to install the batteries again.

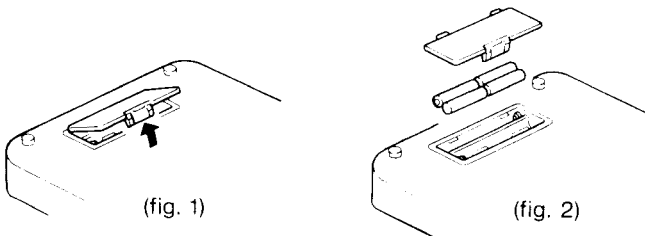

BEFORE USING YOUR SCALE (For kg/lb version only)

Turn the power on by sliding the selection switch to either pound or kilogram, as you prefer. The switch is located at the front left hand corner of the scale.

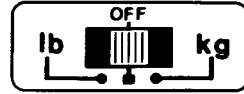

When the scale is being transported, the power switch must be in the OFF position.

For weighing

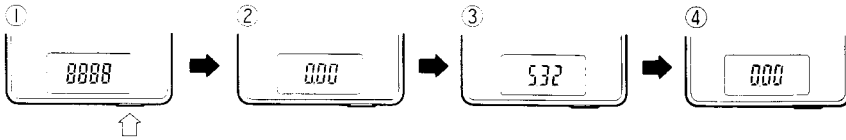

- 1 Press the start-switch
- 2 Display will show 000 . (Do not weigh before the display shows 000)
- 3 Place the baby on the scale within 60 seconds
- 4 After a few seconds, display will return to 000 , and turn off automatically

Tare function

Before weighing baby, the weight of any protective paper or napkin placed in the basket can be deducted by pressing the start switch and obtaining zero. Baby can then be weighed within 60 seconds. (Total weight has to be within 20kg or 44lb. If total weight exceeds 20kg or 44lb, the display will show OL .)

Cautions in Using the Scale

- When pressing the start switch, do not touch other parts. Touching other parts might cause the display of minus figures such as -0.04 or -0.10. Press the start switch again to reset to zero.
- Ensure not to lift the scale by its baby basket. Always hold its body.
- As the scale contains electronic parts, ensure not to put water on the scale or place the scale in a humid location. To clean simply use a damp cloth.
- The scale is a precision instrument; do not drop it, jump on, or drop a heavy object onto it.
- If LO appears on the display, replace the batteries with new ones at once. LO will not appear if battery voltage is too low.
- Do not dismantle or adjust the scale.
- If not in use for long periods, remove the batteries.

Mode Selection

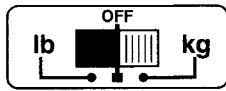
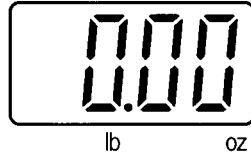
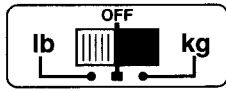

Distributors _____

TANITA CORPORATION

PRINTED IN JAPAN

15847811(2)