



Dual Frequency Body Composition Monitor
with integrated Bluetooth technology

innerScan®
DUAL

RD-953

EN **Instruction Manual**

Please read this Instruction Manual carefully and keep for future reference.

EN Table of Contents

Introduction	3
Features and Functions	3
For Your Safety	4
Getting Accurate Readings	5
Preparations before Use	6
Connecting to Your Smartphone	7
Setting (Resetting) Date and Time	8
Setting and Storing Personal Data in the Memory	9
Taking Measurements with Your Smartphone	11
If you do not have your smartphone when taking measurements	12
Taking Measurements	13
Specifying the Personal Data Number for Measurement	14
Programming the Guest Mode	15
Measuring Weight Only	15
Body Composition Guide	16
Troubleshooting	22
Specifications	23

Introduction

Thank you for purchasing this TANITA Body Composition Monitor. This platform is one of a wide range of home health care products produced by TANITA. This Instruction Manual will guide you through the setup procedures and outline the key features of this platform. Additional information on healthy living can be found on our website www.tanita.com TANITA products incorporate the latest clinical research and technological innovations. All data is monitored by the TANITA Medical Advisory Board to ensure accuracy.



The TANITA Body Composition Monitor is indicated for use in the measurement of weight and impedance, and the estimation of body mass index (BMI), total body fat percent, total body water percent, muscle mass (skeletal and smooth), physique rating, bone mass, visceral fat rating with healthy range, daily calorie intake (DCI), metabolic age, using BIA (Bioelectrical Impedance Analysis). The device is indicated for use for healthy children 7-17 years old and healthy adults with active, moderately active, to inactive lifestyles.

⚠ Safety Precautions

Do not use the Body Composition Monitor if you have an electronic medical implant such as a pacemaker, as it passes a low-level electrical signal through the body which may interfere with the operation of the implant. Pregnant women should only use the weight function. Other functions are not intended for use when pregnant.

Important Notes for Users

This Body Composition Monitor is intended for adults and children (age 7-17) who have inactive to moderately active lifestyles, and adults with athletic lifestyles.

Thanks to major investment in the latest BIA Technology and sports science research, TANITA has upgraded the Athlete Mode function to make measurements more accurate and suitable for a wider range of users. Who should use Athlete Mode?

Adults aged 18 years and over who either:

- Train or exercise for 12 hours or more a week and have been doing so for at least six months.
- Are body builders.
- Are professional athletes who want to monitor their progress at home.
- Have a lifetime history of fitness and who used to do more than 12 hours a week but do less now.

Recorded data may be lost if the unit is used incorrectly or is exposed to electrical power surges.

TANITA cannot accept any responsibility for losses incurred due to the loss of recorded data.

TANITA cannot accept any responsibility for damages or losses incurred through the use of this product or any third-party claims.

Note: Body fat percentage estimates will vary with the amount of water in the body, and can be affected by dehydration or over hydration due to such factors as alcohol consumption, menstruation, illness, intense exercise, etc.

Features and Functions

Front

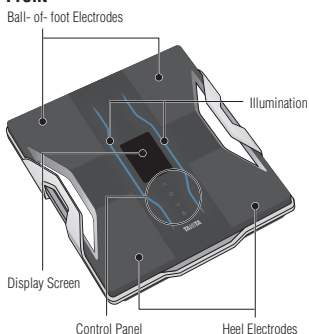

Up / Recall Button

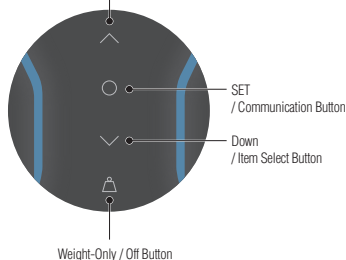

Location Code



Back

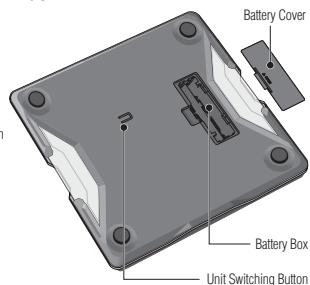

Quick Start Guide





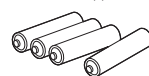

Accessories

AA-Size Batteries (4)



For Your Safety

This section explains precautionary measures to be taken to avoid injury to the users of this device and others, and to prevent damage to property. Please familiarize yourself with this information to ensure safe operation of this equipment.

	Warning	Failure to follow instructions highlighted with this mark could result in death or severe injury.
	Caution	Failure to follow instructions highlighted with this mark could result in injury or damage to property.
		This mark indicates actions that are prohibited.
		This mark indicates instructions that must always be followed.

Warning

 Prohibited	This platform must not be used by people with pacemakers or other medical implants. This platform passes a weak electrical current through the body which could interfere with and cause the malfunction of electrical medical implants, resulting in serious harm to the user.
	Interpretation of measurements (e.g. evaluation of measurements and formulation of exercise programs based on the measurements) must be performed by a professional. Implementing weight loss measures and exercise programs based on self-analysis could be harmful to your health. Always follow the advice of a qualified professional.
	Do not step on the edge of the platform. Do not jump onto the platform. Doing so may cause you to fall or slip, resulting in serious injury.
	Do not place this platform on a slippery surface such as a wet floor. Doing so may cause you to fall or slip, resulting in serious injury. It may also cause water to get inside the platform resulting in damage to internal components.
	Do not drop any objects onto the platform. Avoid excessive impact or vibration to the platform. Doing so may damage the glass, resulting in injury.

Caution

 Prohibited	Do not stand on the display screen or control panel.
	Do not insert your fingers into gaps or holes. Doing so may result in injury.
	Do not use rechargeable batteries. Do not use old batteries together with new batteries, or a mix of different types of batteries at the same time. Doing so may cause battery fluid to leak or the batteries to become excessively hot and rupture, resulting in damage to the platform or injury.
	Never allow an infant or small child to carry the platform. The child may drop the platform, resulting in injury.
	This platform is intended for home use only. This platform is not intended for professional use including hospitals, medical or fitness facilities. It is not equipped with the components required for heavy usage. Using the platform in a professional location will invalidate the warranty.

Place the platform on a hard, flat surface where there is minimal vibration to ensure safe and accurate measurement.

Avoid excessive impact or vibration to the platform.

Doing so may damage the platform or cause it to malfunction, or may cause setting to be erased.

Do not use or store this platform in the following locations.

- Locations that are exposed to direct sunlight, near to heaters, or exposed directly to air from air conditioning units, etc.
- Locations where there are severe temperature changes or a large amount of vibration.
- Locations with high levels of humidity or moisture.

Doing so may damage the platform or cause it to malfunction.

Do not step on the platform when your body is wet (immediately after a shower or bath, etc.)

Be sure to thoroughly dry your body and feet before using the platform. Failure to do so may cause you to slip or fall, resulting in injury. Also, the platform cannot take accurate measurements if your body or feet are wet.

Keep away from water.

Do not use boiling water, benzene, thinner, etc. to clean the platform.

If the platform becomes dirty, soak a soft cloth in water or neutral household detergent, wring it out thoroughly and wipe the platform clean, then use a dry cloth to wipe the platform dry.

Do not attempt to disassemble the platform. Do not modify this platform in any way.

Do not wash the platform in water.

Do not submerge this platform in water.

Doing so may damage the platform or cause it to malfunction.

Be sure to insert the batteries with the polarities (+, -) in the correct position.

If the batteries are incorrectly inserted, battery fluid may leak and damage the floor. (If you do not intend to use this platform for a long period of time, it is advisable to remove the batteries before storage.)

Do not use the platform near other products such as microwave ovens that emit electromagnetic waves.

Doing so may cause the platform to malfunction, preventing accurate measurements.

Another person should assist persons with disabilities who may not be able to take a measurement alone.



Always...

Getting Accurate Readings

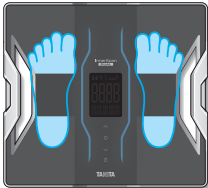

To ensure accuracy, readings should be taken without clothing and under consistent conditions of hydration. Always remove your socks or stockings, and be sure the soles of your feet are clean before stepping on the measuring platform. Be sure that the arch of each foot is aligned with the center of the measuring platform. Don't worry if your feet appear too large for the unit, accurate readings can still be obtained if your toes overhang the platform. It is best to take readings at the same time of day. Try to wait about two hours after getting up, eating, or strenuous exercise before taking measurements. While readings taken under other conditions may not have the same absolute values, they are accurate for determining the percentage change as long as the readings are taken in a consistent manner. To monitor your progress, compare your weight and body fat percentage readings taken under the same conditions over a period of time.

Note: An accurate reading will not be possible if the soles of your feet are not clean, if your knees are bent or if you are sitting down.

Preparations before Use

Inserting the Batteries

Note:

- Be sure that the batteries are inserted in the correct orientation. If the batteries are inserted incorrectly, fluid may leak from the batteries and damage the floor.
- If you do not intend to use this unit for a long period of time, remove the batteries before storage.
- The included batteries from factory may have decreased energy levels over time.

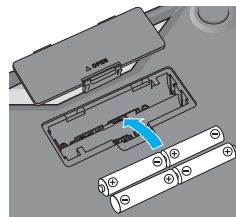

Set your location code

Different locations across the world have different gravitational pulls. These differences affect the accuracy of the weight measurement. You can obtain the most accurate weight readings by selecting the correct gravity setting on the scale according to your geographical location.

1. When the power is off, press and hold the Δ button.
2. Refer to the map enclosed, and press the Δ/∇ buttons to select your location code.
3. Press the \circ button to enter and save the setting.

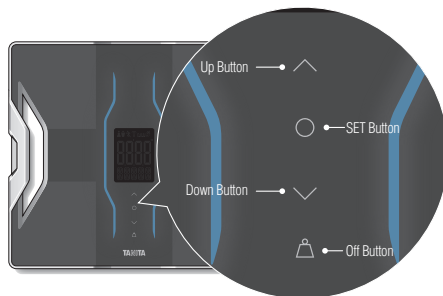

Changing the Weighing Unit

Note: Only for use with models that have the unit switching button.

The weighing unit can be changed using the switch on the back of the platform.

Press the Δ button when the display is blank. When "0.0lb" (or "0.00kg", "0.0stlb") appears on the display, press the Unit Switching button underside of the platform to switch the weighing unit.

Note: If weighing unit is set to pounds or stone-pounds, the height programming mode is automatically set to feet and inches. Similarly, if kilograms is selected, height is automatically set to centimeters.

Connecting to Your Smartphone

1. Download the App & Turn Bluetooth On

Visit the App Store/Google Play Store to download the "Healthy Edge Mobile" App.
Turn the Bluetooth setting on.



2. Set your "Profile"

Open the App.
Open "Settings" and then register your profile details.
Return to the previous screen.

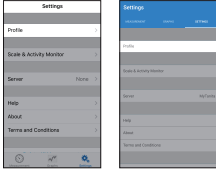

3. "Server"

Fill out your info registered at my.tanita.com in "Server" under "Settings".
Measurement results can be uploaded to my.tanita.com after measurement.
Touch "Save" to return to the previous screen.

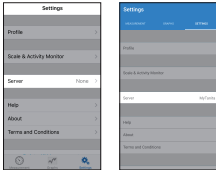

4. "Scale" Settings

Touch "+" and follow the instructions in the App to register your platform.
Return to the previous screen.

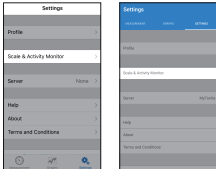

5. Measurement

Touch , and then follow the instructions in the App.

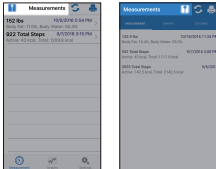

6. Measurement Results

Results are automatically sent to your smartphone and are displayed in the App.
Touch "Save" to store the results in the App.

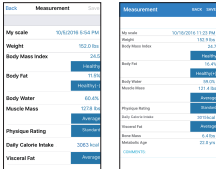

Setting (Resetting) Date and Time (Not required if connection to the smartphone is complete)

1. Set Date

While the power is off, press the \bigcirc button to start setting.
 Press the \wedge / \vee buttons to set year and then press the \bigcirc button.
 Set the month and date in the same way.

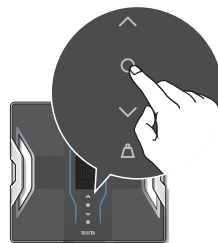

Note:

- When the power is switched on for the first time, the date and time setting screen can also be displayed by pressing the \wedge / \vee buttons.
- When you have replaced the batteries, the date and time setting screen can also be displayed by pressing the \wedge / \vee buttons.



2. Set Time

Press the \wedge / \vee buttons to set hour and then press the \bigcirc button.
 Set the minutes in the same way.
 The set date and time are displayed in order, and then the power automatically turns off.



Note:

- If the Body Composition Monitor is not operated for 60 seconds or more, the power will turn off automatically. Settings will not be saved in this case.
- If you make a mistake or wish to turn the platform off before you complete the settings, press the \triangle button to turn the platform off. Settings will not be saved in this case.
- To change the date or time settings, press and hold the \vee button for 3 seconds when the power is off, and then follow the procedure above to change the date or time settings.

Setting and Storing Personal Data in the Memory (Not required if connection to the smartphone is complete)

The Body Composition Monitor can only be operated if data has been programmed into one of the personal data memories. Only weight measurements can be taken if you use the Body Composition Monitor without registering personal data.

1. Select a Personal Data Number

Press the \bigcirc button to turn on the platform. Press the $\wedge \vee$ buttons to select a personal data number (1, 2, 3 or 4).

Press the \bigcirc button to confirm the personal data number.

Note:

- The platform turns off automatically if it is not operated for 60 seconds.
- If you make a mistake or want to turn the platform off before you have finished programming it, press the \triangle button to force quit. Partially registered data is saved on the platform.
- The backlight color changes according to the personal data number.

- 1:Blue
- 2:Pink
- 3:White
- 4:Light blue



2. Set Your Birthday

Set the date of your birthday (Year / Month / Day) using the $\wedge \vee$ buttons.

Press the \bigcirc button to enter each item.

Note:

Year settings can be configured from 1900 onwards.



3. Select Female or Male

Use the $\wedge \vee$ buttons to scroll through Male [♂], female [♀], male athlete [♂🏃] and female athlete [♀🏃] settings, then press the \bigcirc button.

Who should use Athlete Mode?

Adults aged 18 years and over who either:

- Train or exercise for 12 hours or more a week and have been doing so for at least six months.
- Are body builders.
- Are professional athletes who want to platform their progress at home.
- Have a lifetime history of fitness and who used to do more than 12 hours a week but do less now.



4. Set Your Height

The default height is 5' 7.0" (170cm) (height range is 3'4.0" - 7'3.0" or 100cm - 220cm).

Use the $\wedge \vee$ buttons to set your height and then press the \bigcirc button.



5. Select Activity Level

To use the DCI (Daily Calorie Intake) feature properly, you need to set the Activity Level.

Use the \wedge button to specify Activity Level. Press the \bigcirc button to confirm.

Level 1 = Inactive lifestyles (little or no exercise)

Level 2 = Moderately active lifestyles (occasional, low intensity exercise)

Level 3 = Adult involved in intense physical activity (see p.3 for TANITA's definition of Athlete)

The display shows "0.0lb" (or 0.00kg, 0.0stlb) and the platform is ready for measurement.

Note:

If you select the Athlete Mode, it will automatically set the Activity Level to Level 3.



Setting and Storing Personal Data in the Memory

6. Measuring Your Body Composition

Check "0.0lb" (0.00kg, 0.0stlb) is shown on the display, then step on the platform. Registered personal data and the measurement results are displayed in order, then the power switches off automatically.

Note:

If you step onto the platform before 0.0lb is displayed, "Err,-OL" is displayed and the power turns off. Set the personal information again.

Also, if you do not step onto the platform within 60 seconds of "0.0lb" (0.00kg, 0.0stlb) appearing, the power turns off automatically. In this case, you need to set and store personal data again.

Note:

The platform needs to be connected to the smartphone in order to use the dedicated app.

Connect to the smartphone, and register the Body Composition Monitor as shown in the instructions on page 7.

If you change the birthday and/or gender, "CLr" is displayed on the platform.



Select "YES" using the \wedge / \vee buttons and then press the \bigcirc button, to delete the existing personal data enabling you to register new data.



If you select "no" using the \wedge / \vee buttons and then press \bigcirc button, no new data is saved (existing data is left unchanged) and power turns off.



Taking Measurements with Your Smartphone

1. When the platform power is off, select  in the app and then follow the instructions in the app. When "0.0lb" (0.00kg, 0.0stlb) is displayed, step onto the platform.

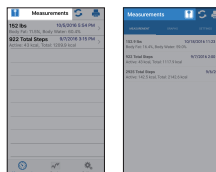

2. Measurement data is automatically sent to your smartphone. If there is unsent data stored on the platform, that data is also sent to your smartphone.

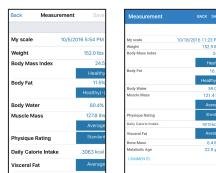

If you do not have your smartphone when taking measurements

Simply step onto the platform. The auto-recognition feature will automatically recall your personal data. Your platform will store up to 10 sets of measurements. Saved data is sent to your smartphone together with new measurements the next time your smartphone is connected to the platform when taking measurements.

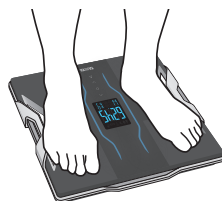

Taking Measurements

You can start taking measurements when you have finished entering your personal data.

1. Step onto the Platform

Step onto the platform when the power is off. The platform starts measuring automatically.



2. View Your Results

After taking measurements, your results are automatically displayed in the order listed on the next page.

After the last result data is displayed, the weight is displayed again and then the platform automatically turns off.

Note:

- Do not step off until “0000” disappears.
- The backlight color changes according to the recognized personal data number. (Blue/Pink/White/Light blue)
- When the platform is connected to the smartphone and measurement data is saved in the platform,  lights in the personal data display and the measurement result display screen.
- If there are more than 6 sets of data stored, the number of saved sets of data is displayed after the personal data display lights.
- Up to 10 sets of measurement data can be stored in the platform.
- If you have set a nickname in the dedicated app, the nickname is displayed instead of the personal data number when personal data is displayed.

If the wrong personal number is displayed

Press the  button to select your personal number while readings or personal data is being displayed.

Then press the  button to display your own personal data and measurement results.

Situations where mis-recognition may occur

- When measuring people who have similar weights and body shapes
 - When measurements have not been taken for a few days and there is a reasonable change in body weight
 - When measuring directly after having the platform stood upright, carrying the platform or storing it with items placed on top
- If the platform continues to mis-recognize, specify your personal data number manually before measurement. (P.14)

Measurement Results

Weight



BMI



Body Fat %



Muscle Mass



Muscle Quality Score



Physique Rating



Bone Mass



Visceral Fat



Daily Calorie Intake



Metabolic Age



Total Body Water %



An assessment of your measurement results are indicated by the color of the backlight.

Assessment Color (Applicable age)	●	●	●
BMI (18-99)	Obese	Over / Under	Normal range
Body Fat Percentage (18-99)	Obese	Over / Under	Standard (-) / Standard (+)
Visceral Fat Level (18-99)	High	Slightly High	Average
Muscle Mass (18-99)	Under	-	Average / High
Muscle Quality Score (18-99)	Under	-	Average / High

Note:

- For children (age 7-17), the platform only displays weight, BMI, body fat percentage.
- For children (age 6 or less) and adults (age over 100), the platform only displays the weight.
- "Err" is displayed if the body fat percentage exceeds the measurable range.
- You can use the \vee button to scroll through the results.
- Press and hold the \vee button for fast scrolling.
- After reading the results that you want to see, release the button to see the rest of the results.
- The platform automatically turns off after 40 seconds.
- Press the \triangle button to cancel measurement or turn the power off.
- Do not move the platform for approximately 3 seconds after taking measurements and stepping off.
To prevent accidents such as falling off the platform, always step off the platform before operating the buttons.

Specifying the Personal Data Number for Measurement

Follow these instructions if the platform continues to mis-recognize your number.

1. When the power is off, press the \wedge button to start measuring.
Select your personal number using the \wedge / \vee buttons and then press the \circ button.



2. Step onto the platform when "0.0lb" (0.00kg, 0.0stlb) appears in the display.
The platform turns off automatically after displaying the measurement results.



Note:

- When the platform is connected to the smartphone and measurement data is saved in the platform, ☑ lights in the personal data display screen and the measurement result display screen.
- If there are more than 6 sets of data stored, the number of saved sets of data is displayed after the personal data display lights.
- Up to 10 sets of measurement data can be stored in the platform.
- If you step onto the platform before "0.0lb" (or "0.00kg", 0.0stlb) is displayed, "Err.-OL" is displayed and the power turns off during measurement.

Programming the Guest Mode

Guest mode allows you to program the platform for one-time use without using a personal data number.

Press the \wedge button to select "GUEST", then press the \circ button.

Next, follow the steps below:

Set the age, gender (male/ female/ male athlete/ female athlete), height and activity level (adult and non-athlete only)

Step onto the platform after "0.0lb" (or "0.00kg", 0.0stlb) is displayed.

The readings are displayed for 40 seconds.

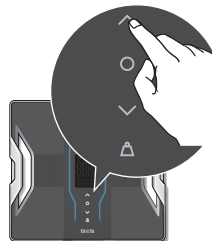

Note:

The age range is from 7 to 99.

Who should use Athlete Mode?

Adults aged 18 years and over who either:

- Train or exercise for 12 hours or more a week and have been doing so for at least six months.
- Are body builders.
- Are professional athletes who want to monitor their progress at home.
- Have a lifetime history of fitness and who used to do more than 12 hours a week but do less now.
- Do not step off until "0000" disappears.

Measuring Weight Only

Press the \triangle button. After 2 or 3 seconds, "0.0lb" (or "0.00kg", 0.0stlb) is displayed.

When "0.0lb" (or "0.00kg", 0.0stlb) is displayed, step onto the platform.

The body weight measurement is displayed, and the platform power turns off automatically after approximately 20 seconds.

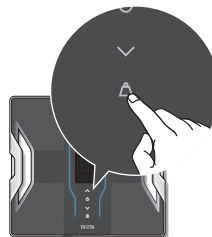

Body Composition Guide

Who Can Use a Body Composition Monitor?

This Body Composition Monitor is intended for adults aged 18-99 years. Children aged 7-17 years can use the platform for weight and body fat percentage readings and BMI only; the other features are not applicable to children.

Thanks to major investment in the latest BIA Technology and sports science research, TANITA has upgraded the Athlete Mode function to make measurements more accurate and suitable for a wider range of users.

Who should use Athlete Mode?

Adults aged 18 years and over who either:

- Train or exercise for 12 hours or more a week and have been doing so for at least six months.
- Are body builders.
- Are professional athletes who want to monitor their progress at home.
- Have a lifetime history of fitness and who used to do more than 12 hours a week but do less now.

Pregnant women should only use the weight function.

Other functions are not intended for use when pregnant.

This Body Composition Monitor is intended for home use only. It is not intended for professional use in places such as hospitals or medical or fitness facilities. It is not designed for such heavy usage. Using the platform in this type of professional environment will invalidate the warranty.

This Body Composition Monitor product provides readings for informational purposes only.

This product is not intended to diagnose or treat any disease or abnormalities. Please consult your physician if you have any questions or concerns related to your health.

How Does a Body Composition Monitor Work?

TANITA Body Composition Monitors calculate your body composition using Dual Frequency Bioelectrical Impedance Analysis (BIA). Safe, low-level electrical signals are passed through the body via the TANITA foot pads on the platform. The signal can flow easily through fluids in muscles and other body tissue but meets resistance as it passes through body fat, because body fat only contains a small amount of fluid. This resistance is called impedance. The impedance readings are then entered into medically researched mathematical formulas to calculate your body composition.

The TANITA RD-953 incorporates medical grade Dual Frequency BIA technology, allowing you to have the highest body composition accuracy in the comfort of your home.

Research has shown that using two different bioelectrical impedance frequencies, provides essential data of a person's intracellular and extracellular status. This advanced technology allows greater accuracy when calculating body composition measurements.

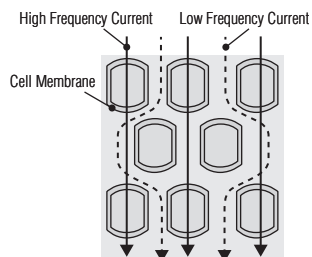

When Is the Best Time To Use My Body Composition Monitor?

Your body water levels naturally fluctuate throughout the day and night. Any significant changes in body water may affect your body composition readings. For example, the body tends to be dehydrated after a long night sleep so if you take a reading first thing in the morning your weight will be lower and your body fat percentage higher. Eating large meals, drinking alcohol, menstruation, illness, exercising, and bathing may also cause variations in your hydration levels.

To get the most reliable reading it is important to use your Body Composition Monitor at a consistent time of day under consistent conditions. A good time to take measurements is before your evening meal.

What Is Body Fat Percentage?

Body fat percentage is the amount of body fat as a proportion of your body weight. Reducing excess levels of body fat has been clinically proven to reduce the risk of certain conditions such as high blood pressure, heart disease, diabetes and cancer.

The chart below shows the healthy ranges of body fat.

Body Fat Ranges for Standard Children 1

Body Fat Ranges for Standard Adults 2,3,4

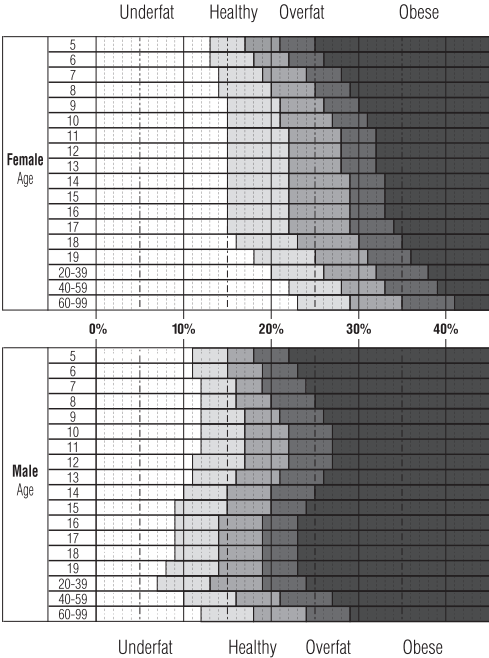

1. Body Fat Reference Curves for children Targeted at BMJ (British Medical Journal) Draft 1-AMP 19 June 2004 (by Dr Andrew)
2. Gallagher D et al. Am J Clin Nutr 2000, 72:694-701 Healthy percentage body fat ranges: an approach for developing guidelines based on body mass index.
3. Based on NIH/WHO BMI Guidelines.
4. As reported by Gallagher, et al, at NY Obesity Research Center.
To determine the percentage of body fat that is appropriate for your body, consult your physician.

Underfat: Below the healthy body fat range. Increased risk of health problems.
 -Healthy • +Healthy: Within the healthy body fat percentage range for your age/gender.
 Overfat: Above the healthy range. Increased risk of health problems.
 Obese: Far above the healthy body fat range.
 Greatly increased risk of obesity-related health problems.

What Is Total Body Water Percentage? (Applicable age 18-99)

Total Body Water Percentage is the total amount of fluid in a person's body expressed as a percentage of their total weight. Water plays a vital role in many of the body's processes and is found in every cell, tissue and organ. Maintaining a healthy total body water percentage ensures the body functions efficiently and reduces the risk of developing associated health problems.

Your body water levels naturally fluctuate throughout the day and night. Your body tends to be dehydrated after a long night's sleep and there are differences in fluid distribution between day and night. Eating large meals, drinking alcohol, menstruation, illness, exercising and bathing may cause variations in your hydration levels.

Your body water percentage reading should be used as a guide and should not be used to specifically determine your recommended total body water percentage. It is important to look for long-term changes in total body water percentage and maintain a consistent, healthy total body water percentage.

Drinking a large quantity of water in one sitting will not instantly change your body water level. In fact, it will increase your body fat reading due to the additional weight gain. Please monitor all readings over time to track relative changes.

Every individual is different, but as a guide the average total body water percentage ranges for a healthy adult are:

Female: 45 to 60%

Male: 50 to 65%

Source: TANITA Research

Note: The total body water percentage will tend to decrease as the percentage of body fat increases. A person with a high percentage of body fat may fall below the average body water percentage. As you lose body fat, the total body water percentage should gradually move towards the typical range given above.

What Is Visceral Fat Rating? (Applicable age 18-99)

This function indicates the amount of visceral fat in your body.

Visceral fat is the fat that is in the internal abdominal cavity, surrounding the vital organs in the abdominal area. Research shows that even if your weight and body fat remains constant, as you get older the distribution of fat changes and is more likely to shift to the abdominal area especially post menopause. Ensuring you have healthy levels of visceral fat may reduce the risk of certain diseases such as heart disease, high blood pressure, and the onset of type 2 diabetes.

The TANITA Body Composition Monitor provides you with a visceral fat rating from 1 – 59.

Rating 1 - 12

Indicates you have a healthy amount of visceral fat. Continue monitoring your rating to ensure that it stays within this healthy range.

Rating 13 - 59

Indicates you have an excess amount of visceral fat. Consider making changes in your lifestyle by changing your diet or exercising more.

Source : Data from Columbia University (New York) & TANITA Institute (Tokyo)

Note: You may have a high visceral fat level even if you have a low body fat rate.

- Consult a physician for an accurate medical diagnosis.

What Is Daily Calorie Intake(DCI)? (Applicable age 18-99)

"Daily Calorie Intake (DCI)" is the sum of calories for basal metabolism, daily activity metabolism (activities including dailychores), and diet-induced thermogenesis (energy used in connection with digestion, absorption, metabolism, and other eating activities). It is an estimate of how many calories you can consume within the next 24 hours to maintain your current weight.

How Does a TANITA Body Composition Monitor Calculate DCI?

The basic way of calculating Basal Metabolic (BMR) Rate is a standard equation using weight and age. TANITA has conducted in-depth research into the relationship of BMR and body composition giving a much more accurate and personalized reading for the user based on the impedance measurement. This method has been medically validated using indirect calorimetry (measuring the breath composition).*

$$DCI = BMR \times \text{Activity Level}$$

	1	2	3
Female	1.56	1.64	1.82
Male	1.55	1.78	2.10

*Reliability on equation for Basal Metabolic Rate: At 2002 Nutrition Week: A Scientific and Clinical Forum and Exposition Title: International Comparison: Resting Energy Expenditure Prediction Models: The American Journal of Clinical Nutrition.

Source: World Health Organization(WHO)

What Is Metabolic Age? (Applicable age 18-99)

This function calculates your BMR and indicates the average age associated with the type of metabolism.

If your metabolic age is higher than your actual age, it is an indication that you need to improve your metabolic rate. Increased exercise

builds healthy muscle tissue, which improves your metabolic age.

The reading is shown as a number between 12 and 90. Values under 12 are displayed as "12" and over 90 are displayed as "90".

What Is Muscle Mass? (Applicable age 18-99)

This function indicates the weight of muscle in your body. The muscle mass displayed includes skeletal muscle, smooth muscle (such as cardiac and digestive muscle) and the water contained in these muscles.

Muscles play an important role as they act as an engine that consumes energy. As your muscle mass increases, your energy consumption increases helping you reduce excess body fat levels and lose weight in a healthy way.

What Is Physique Rating? (Applicable age 18-99)

This feature assesses your physique according to the ratio of body fat and muscle mass in your body.

As you become more active and reduce the amount of body fat, your physique rating also changes accordingly. Even if your weight does not change, your muscle mass and body fat levels may be changing to make you healthier and reduce your risk of certain diseases. Each person should set their own goal of which physique they want to achieve, and follow a diet and fitness program to meet that goal.

Result	Physique Rating	Explanation of Physique Rating Results
1	Hidden Obese	Small Frame Obese This person seems to have a healthy body type based on physical appearance. However, they have a high body fat percentage with low muscle mass level.
		Medium Frame Obese This person seems to have a healthy body type based on physical appearance. However, they have a high body fat percentage with low muscle mass level.
2	Obese	Large Frame Obese This person has both a high body fat percentage and a high muscle mass.
		Low Muscle and Average Body Fat Percentage This person has an average body fat percentage and a less than average muscle mass level.
3	Solidly-built	Ave. Muscle & Ave. Body Fat Percentage This person has average levels of both body fat and muscle mass.
		High Muscle & Ave. Body Fat Percentage (Athlete) This person has an average body fat percentage and higher muscle mass level than average.
4	Under exercised	Low Muscle & Low Fat Both body fat percentage and muscle mass are lower than average.
		Thin and muscular (Athlete) This person has a lower than average body fat percentage while having adequate muscle mass.
5	Standard	Very Muscular (Athlete) This person has a lower than average body fat percentage while having above-average muscle mass.
6	Standard Muscular	
7	Thin	
8	Thin and muscular	
9	Very Muscular	

Source: Data from Columbia University (New York) & TANITA Institute (Tokyo)

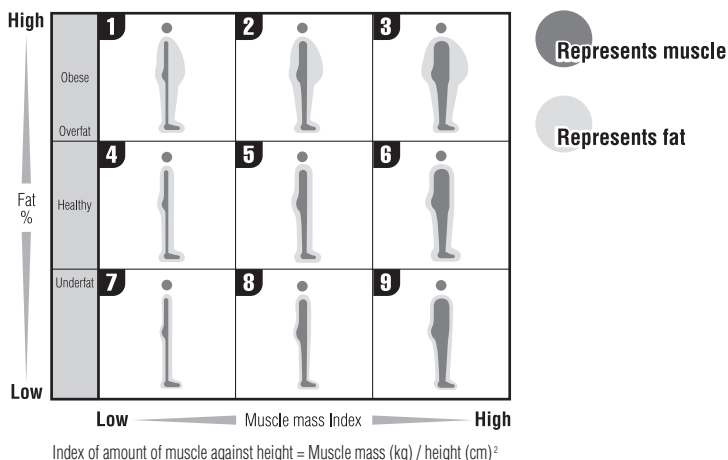

What Is Muscle Quality Score? (Applicable age 18 - 99)

Muscle quality score indicates the “quality (state) of muscle” which changes according to factors such as age and fitness. The muscles of young people or those who exercise regularly is normally in a good state, but the state of muscles deteriorates in elderly people or those who do not get enough exercise. Inner Scan Dual Body Composition Analyzer uses 2 different frequencies to measure Bioelectrical Impedance, these results are used to evaluate intracellular water(ICW) and extracellular water(ECW) to determine the muscle state using the Muscle Quality Score. Inside muscle fibers, there is protein and water. As muscle fibers grow as a result of strength and conditioning exercise, muscle protein increases and consequently the ICW increases. Through understanding an individual’s ICW and ECW, Muscle Quality score can be calculated.

Muscle Quality Judgement Chart

Male	18 – 29	30s	40s	50s	60s	70s	80 and over
High	74 and higher	73 and higher	70 and higher	64 and higher	56 and higher	46 and higher	39 and higher
Average	49 – 73	47 – 72	44 – 69	39 – 63	33 – 55	25 – 45	21 – 38
Low	48 or less	46 or less	43 or less	38 or less	32 or less	24 or less	20 or less

Female	18 – 29	30s	40s	50s	60s	70s	80 and over
High	68 and higher	70 and higher	69 and higher	67 and higher	61 and higher	54 and higher	50 and higher
Average	48 – 67	48 – 69	45 – 68	41 – 66	34 – 60	26 – 53	22 – 49
Low	47 or less	47 or less	44 or less	40 or less	33 or less	25 or less	21 or less

*Muscle Quality Score may not be accurately evaluated if there are abnormalities in the state of body water, such as in the following conditions:

- If the body fatigued or swollen.
- If the person is dehydrated or suffering from reduced blood flow.

It is important to maintain a good balance between muscle mass and quality.

Note:

More ★ indicates a better state of muscle.
(Max. ★★★★★)

Balance Between Muscle Mass and Muscle Quality

Muscle Quality Judgement	High	★★	★★★	★★★★★
	Average	★★	★★★	★★★★
	Low	★	★	★★
		Low	Average	High
Muscle Mass Judgement				

Troubleshooting

If the following problems occur, follow the instructions below.

“Lo” appears on the display.

Check the orientation of the batteries, and insert them correctly.

The batteries are running low. Replace the batteries promptly.

Refer to page 6.

“OL” appears on the display during use

The maximum weight (weighing capacity) 440lb (200kg) is exceeded. (Measurements cannot be taken)

“Err” appears on the display after measurement

Are the personal data settings correct?

Did you select the wrong personal data number?

Measurement items have exceeded the measurement range. (Measurements cannot be taken)

Cannot measure body composition even though personal data is set

The personal data settings are not complete. You need to measure body composition once immediately after entering the personal data.

Cannot connect my smartphone to the Body Composition Monitor

“Err pair” or “Err DATA” appears on the display

Are batteries inserted correctly in the Body Composition Monitor?

Are the batteries running low?

Are the smartphone and body composition meter within communication range?

The communication range for the Body Composition Monitor is 16.4ft (5m) in an unobstructed location.

Is the “Bluetooth” setting in the smartphone “Settings” turned on?

“Err pair” appears repeatedly.

Delete the pairing information from “Settings” > “Bluetooth” on the smartphone, and pair the smartphone with the Body Composition Monitor again.

“Err UUID” appears repeatedly.

Delete the pairing information from “Settings” > “Bluetooth” on the smartphone, and pair the smartphone with the Body Composition Monitor again.

“Err c9” appears on the display

Remove and replace the batteries from the Body Composition Monitor, and set the date and time again.

The date and time settings have been changed

When using the Body Composition Monitor linked with your smartphone, the date and time settings on the Body Composition Monitor are overwritten with those from the smartphone.

The “Input Data” button in the app does not work

Is the “Bluetooth” setting in the smartphone. “Settings” turned on?

Linking between the app and the Body Composition Monitor is only enabled when the Body Composition Monitor is turned off.

Check that the power of the Body Composition Monitor is turned off and try again.

Specifications

RD-953

Weight Capacity

200 kg (440 lb)(31st 6 lb)

Weight Increments

0-100 kg/0.05 kg 100-200 kg/0.1 kg

0-200 lb/0.1 lb 200-440 lb/0.2 lb 0-31st 6 lb/1 lb

Body Fat %

7-99 years old

Body Mass Index

7-99 years old

Muscle Mass

18-99 years old

Muscle Quality Score

18-99 years old

Physique Rating

18-99 years old

Bone Mass

18-99 years old

Visceral Fat

18-99 years old

Daily Calorie Intake

18-99 years old

Metabolic Age

18-99 years old

Body Water %

18-99 years old

Personal Data

4 memories

Power Supply

4×AA Alkaline batteries(included)

Power Consumption

250mA maximum

Measuring Current

50kHz, 6.25 kHz, 100µA

Communication Method

Bluetooth version 4.0 (Low Energy support)

USA

Federal Communications Commission

This equipment has been tested and found to comply with the limits for a Class B digital device, pursuant to Part 15 of the FCC Rules. These limits are designed to provide reasonable protection against harmful interference in a residential installation. This equipment generates, uses and can radiate radio frequency energy and, if not installed and used in accordance with the instructions, may cause harmful interference to radio communications. However, there is no guarantee that interference will not occur in a particular installation. If this equipment does cause harmful interference to radio or television reception, which can be determined by turning the equipment off and on, the user is encouraged to try to correct the interference by one or more of the following measures:

- Reorient or relocate the receiving antenna.
- Increase the separation between the equipment and receiver.
- Connect the equipment into an outlet on a circuit different from that to which the receiver is connected.
- Consult the dealer or an experienced radio or television technician for help.



•The product design and specifications may be changed at any time without prior notice.

•Apple, the Apple logo, and iPhone are trademarks of Apple Inc., registered in the U.S. and other countries. App Store is a service mark of Apple Inc.

•Google, Google Play and Android are trademarks of Google Inc.

•The Bluetooth® word mark and logos are registered trademarks owned by Bluetooth SIG, Inc. and any use of such marks by TANITA Corporation is under license.

Manufacturer

TANITA Corporation

1-14-2 Maeno-cho, Itabashi-ku,

Tokyo 174-8630 Japan

TEL: +81-(0)3-3968-7048

www.tanita.co.jp

EU Representative

TANITA Europe B.V.

Hoogoorddreef 56-E, 1101 BE

Amsterdam, the Netherlands

TEL: +31-(0)20-560-2970

FAX: +31-(0)20-560-2988

www.tanita.eu

TANITA Corporation of America, Inc.

2625 South Clearbrook Drive,

Arlington Heights, Illinois 60005

U.S.A.

TEL: +1-847-640-9241

FAX: +1-847-640-9261

www.tanita.com

TANITA Health Equipment H.K. Ltd.

Unit 301-303, Wing On Plaza, 3/F., 62 Mody Road,

Tsimshatsui East, Kowloon, Hong Kong

TEL: +852-2834-3917

FAX: +852-2838-8667

www.tanita.asia

TANITA (Shanghai) Trading Co., Ltd.

Room 8005, 877 Huai Hai Zhong Lu, Shanghai,

The People's Republic of China

TEL: +86-21-6474-6803

FAX: +86-21-6474-7901

TANITA India Private Limited

A-502, Mittal Commercial, Off. M.V. Road (Andheri Kurla Road)

Marol, Andheri-East,

Mumbai, India 400 059

TEL: +91-771-801-1511

www.tanita.co.in